

Schutzvermerk ISO 16016 beachten. / Refer to protection notice ISO 16016.

Vakuumentchnik

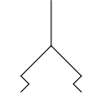

Vakuum Sauger



Vakuum Sauger

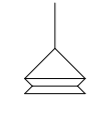

Vakuum Sauger

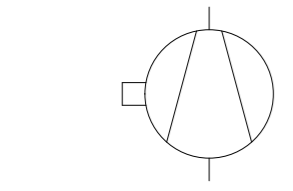

Vakuum Pumpe

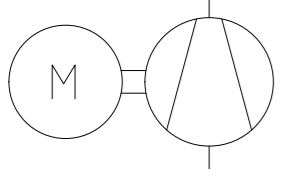

Vakuum Pumpe mit Motor

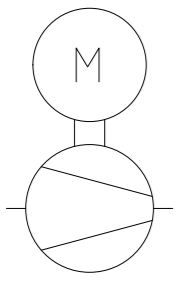

Vakuum Pumpe mit Motor



Vakuumentank

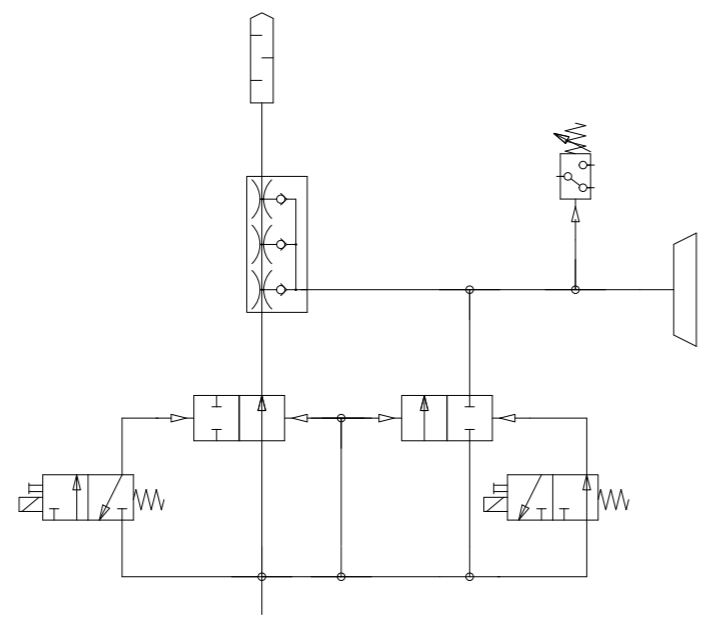

Vakuum Ejektor

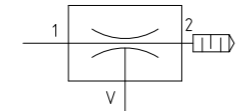

Vakuum Ejektor

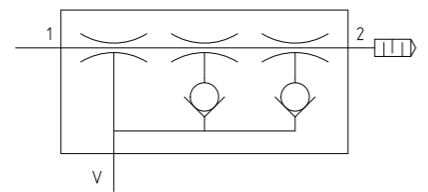

Vakuum Ejektor mehrstufig

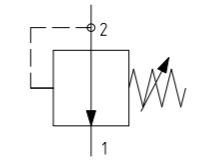

Vakuumregelventil vertikal

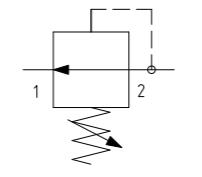

Vakuumregelventil horizontal

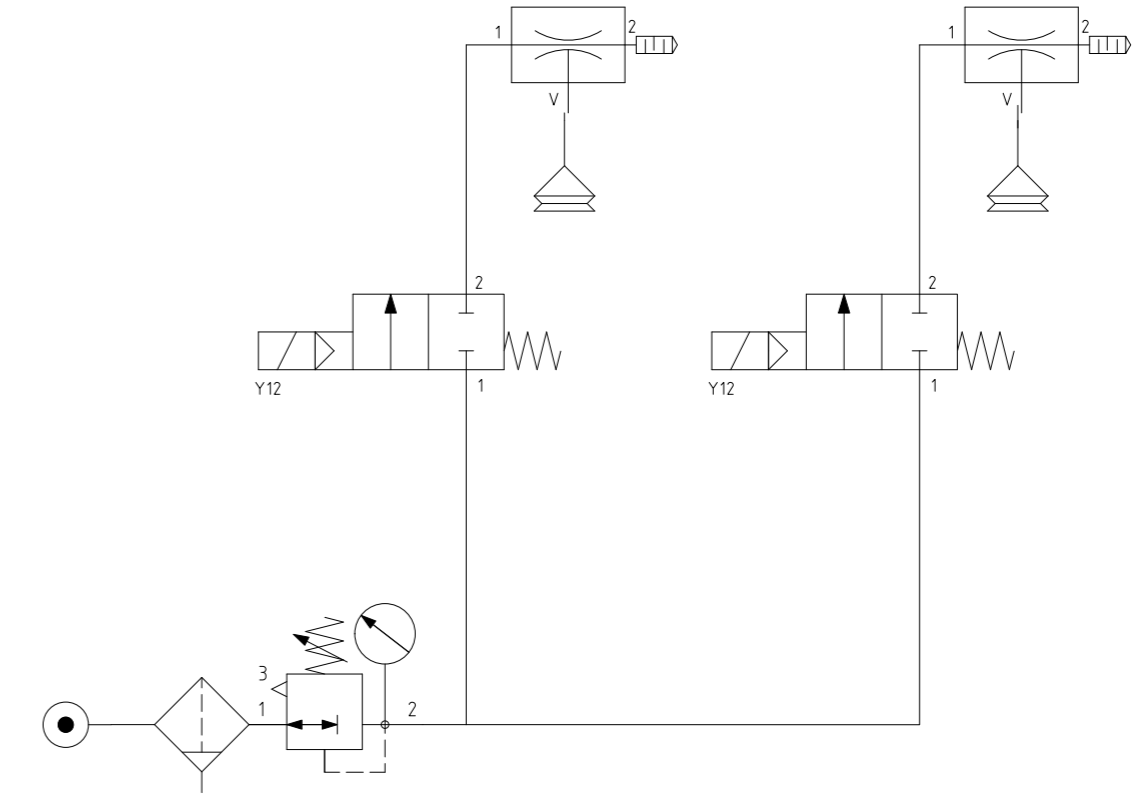
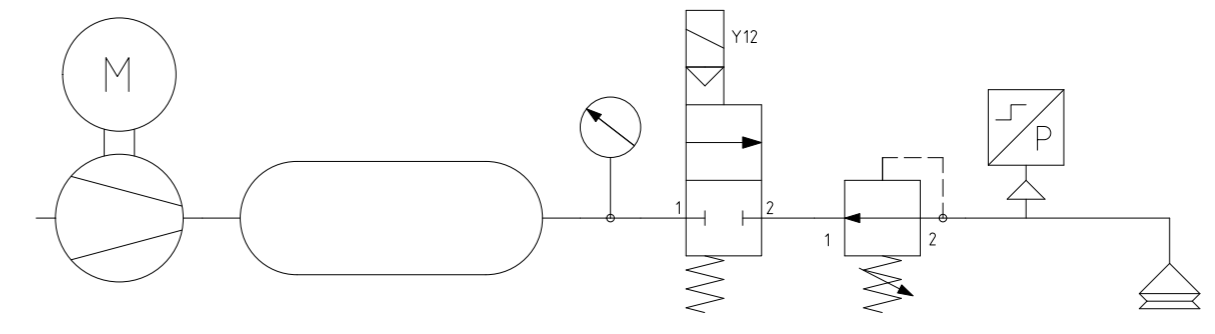

Index	Änd.-Nr.	Name	Benennung:	Datum	Name
gezeichnet	01.01.2020	Admin	Vakuum	Zeichnungsnummer:	
geprüft				Pneumatik	
normed					
Ursprung:			www.cad-symbole.com	Maßstab:	1:1
				Zeichnungstyp:	Format A2
				Blatt	1 von 1