

Schutzvermerk ISO 16016 beachten. / Refer to protection notice ISO 16016.

Wartungseinheiten



Wartungseinheit-mit-Öler



Wartungseinheit-ohne-Öler

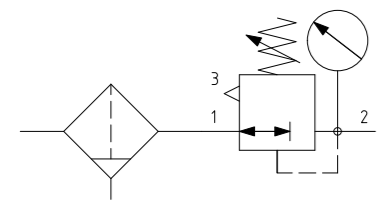

Filterregler, manueller Kondensatablass

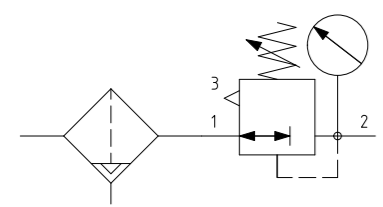

Filterregler, autom. Kondensatablass

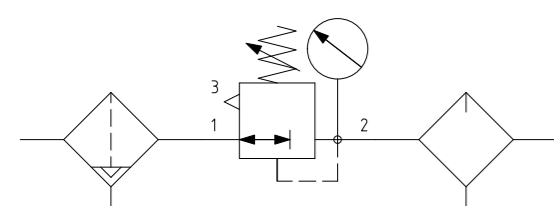

Wartungseinheit mit Öler

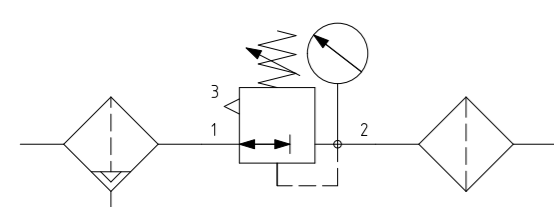

Wartungseinheit mit Feinfilter

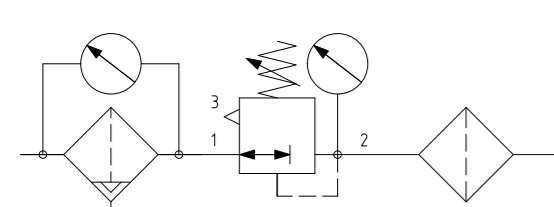

Wartungseinheit mit Feinfilter, Differenzdruckanzeige

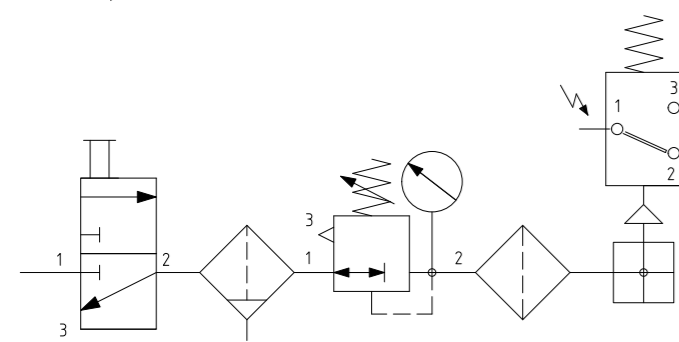

Wartungseinheit, mit Absperrventil, Feinfilter, Druckschalter

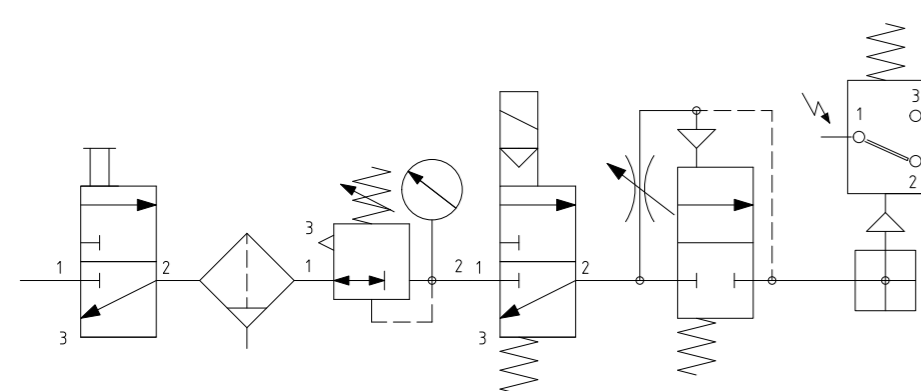

Wartungseinheit, mit Absperrventil, elektr. Einschaltventil, Softstart, Druckschalter

Druckluftaufbereitung, Filter etc.

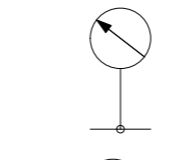

Manometer

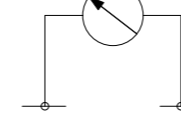

Manometer, Differenzdruck

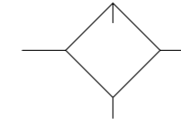

Öler

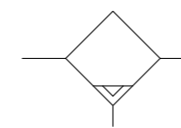

Wasserabscheider, autom. Kondensatablass

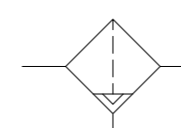

Filter, autom. Kondensatablass

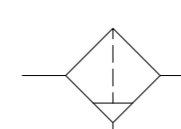

Filter, manueller Kondensatablass

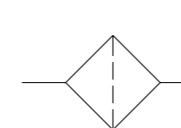

Filter - allgemein

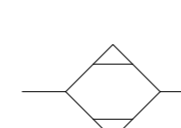

Trockner

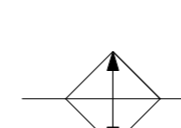

Kühler



Anschlussblock

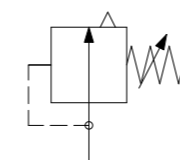

Überdruckventil / Sicherheitsventil



Drucklufttank

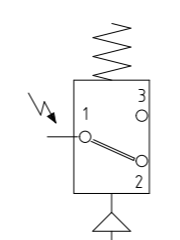

Druckschalter

Einschaltventile

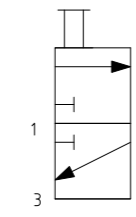

Absperrventil, handbetätigt

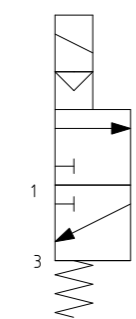

Absperrventil, elektrisch

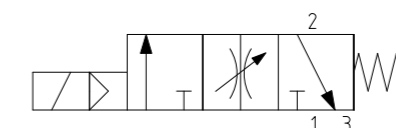

Softstartventil 3/3 WV - elektrisch - horizontal

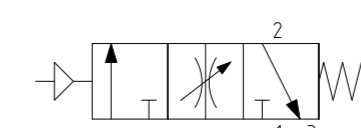

Softstartventil 3/3 WV - pneumatisch - horizontal

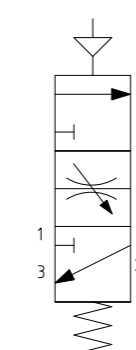

Softstartventil 3/3 WV - pneumatisch - vertikal

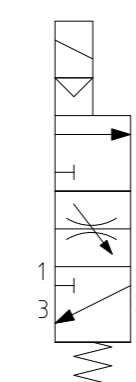

Softstartventil 3/3 WV - elektrisch - vertikal

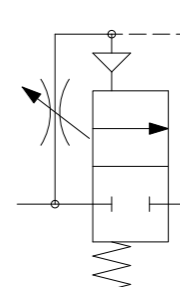

Druckaufbauventil, pneumatisch

Index	Änd.-Nr.	Änderung		Datum	Name
gezeichnet	01.01.2020	Name	Admin	Benennung: Luftaufbereitung	
geprüft				Zeichnungsnummer: Pneumatiksymbole	
normed				www.cad-symbole.com	
Ursprung:				Maßstab: 1:1	Blatt 1 von 1
				Zeichnungstyp: A2	