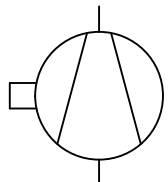

# Vakuumentchnik

 Vakuu Sauger

 Vakuu Sauger

 Vakuu Sauger

 Vakuu Pumpe

 Vakuu Pumpe mit Motor

 Vakuu Pumpe mit Motor

 Vakuutank

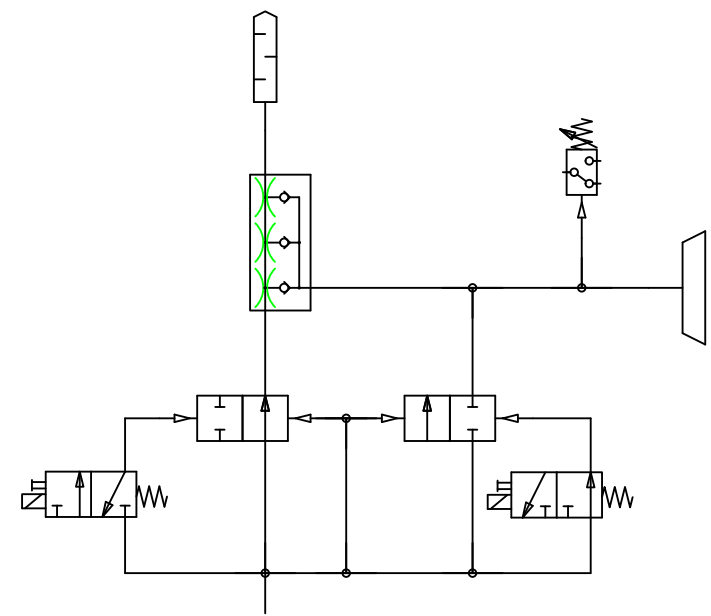

Vakuu Ejektor

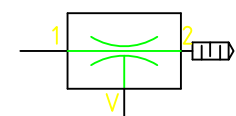

Vakuu Ejektor

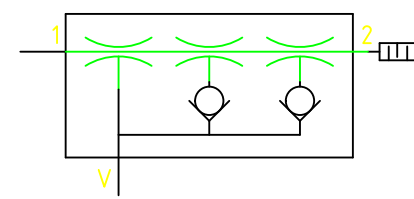

Vakuu Ejektor mehrstufig

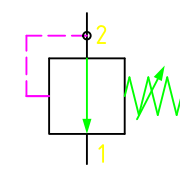

Vakuuregelventil vertikal

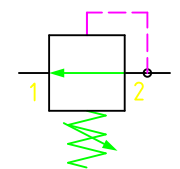

Vakuuregelventil horizontal

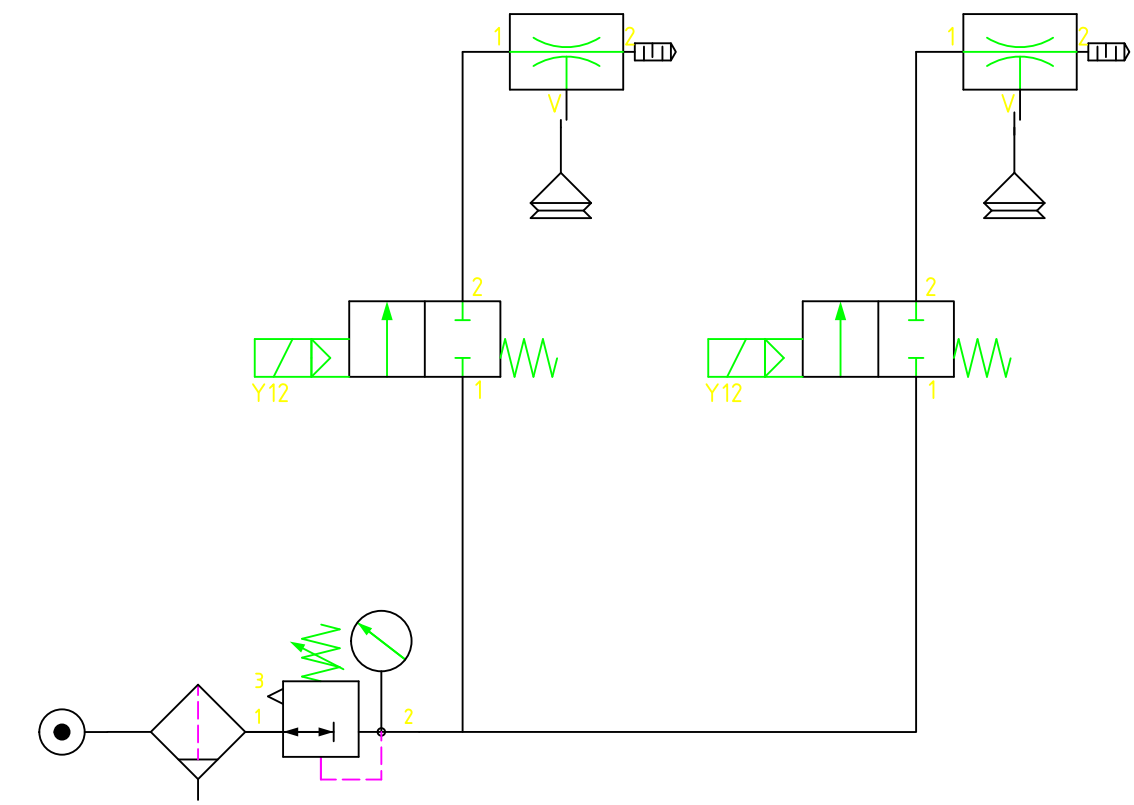
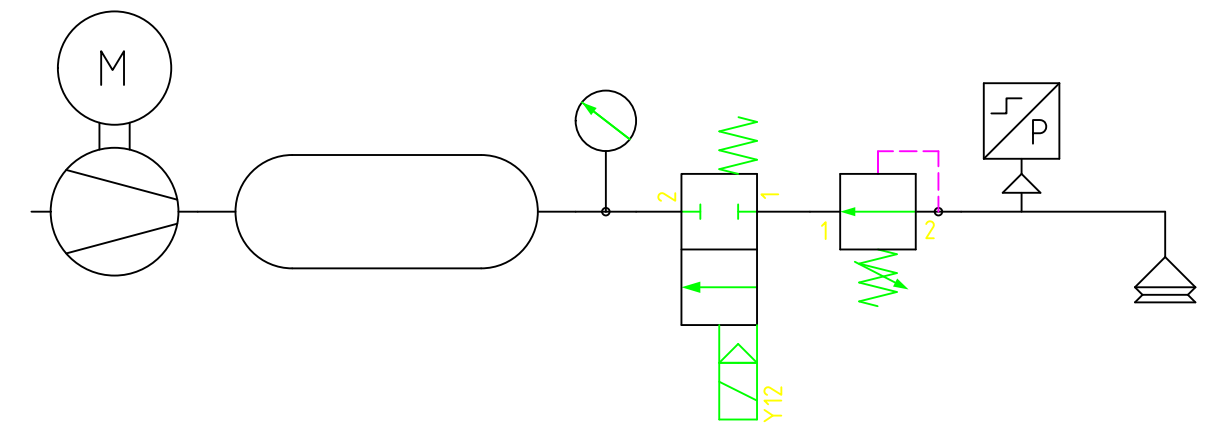

Ind.	Mittlgs.-Nr.	Änderung	Datum	Name
Erstellt	01.01.2019	Name Admin	Benennung Vakuu	
Gepr.			Zeichnungs-Nr. Pneumatik	
Norm.			www.pneumatikplan.de	
entstanden aus:		Maßstab 1:1	Zeichnungstyp: Format A2	
				1 von 1

Schutzvermerk nach DIN 34 beachten